

PRODUCT: FASTLANE COMPACT	
TITLE: GENERAL DIMENSIONS	
DRAWN: RST	DRAWING No: S665_07_A0
DATE: 18.10.02	This document is the copyright of Integrated Design Ltd

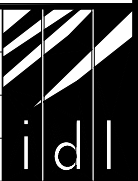

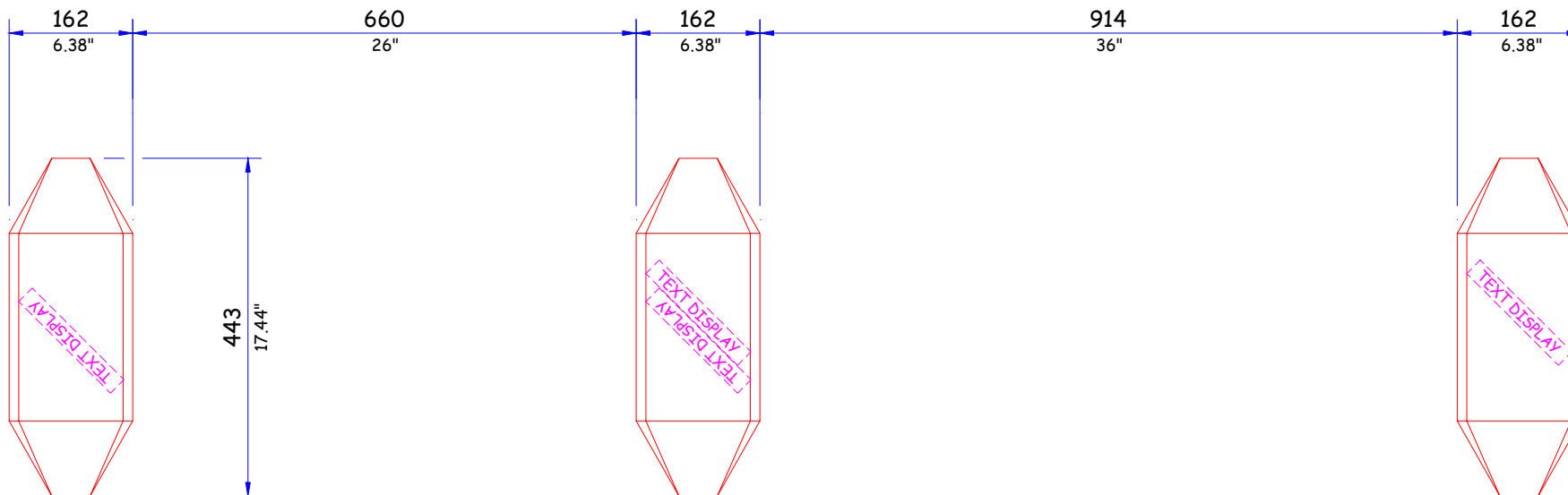

STANDARD LANE WIDTH
STANDARD ACCESS

EXTENDED LANE WIDTH
* DISABLED ACCESS

* SUBJECT TO LOCAL LEGISLATION

THIS DRAWING SHOWS TYPICAL LANE WIDTHS.
LANES CAN BE BETWEEN 600mm & 1000mm. (23.6" & 39.4")

PRODUCT: FASTLANE COMPACT	
TITLE: GENERAL LAYOUT	
DRAWN: RST	DRAWING No: S665_08_A0
DATE: 1.1.03	This document is the copyright of Integrated Design Ltd

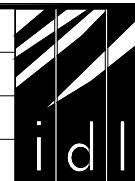

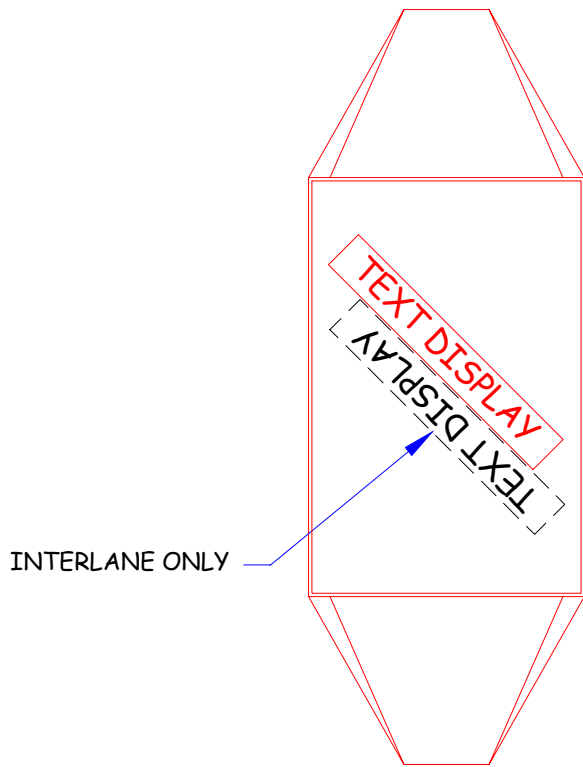

STANDARD DISPLAY LAYOUT

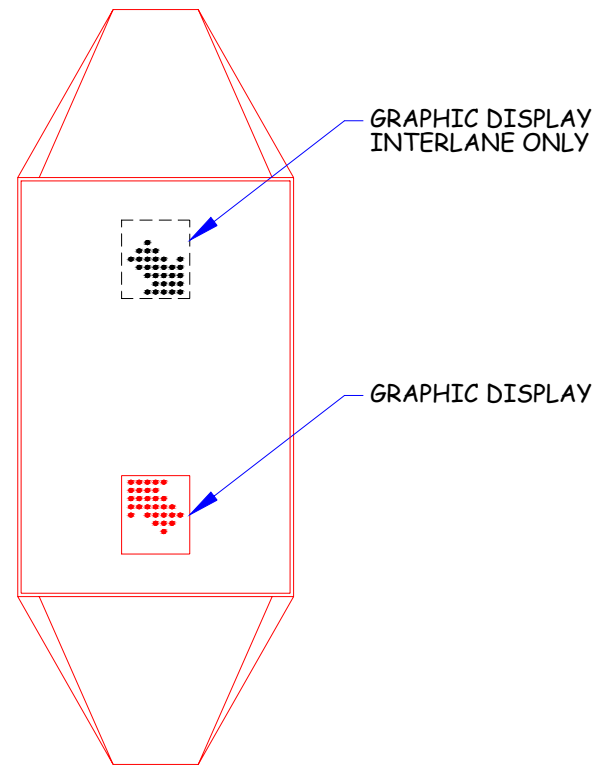

OPTIONAL GRAPHIC DISPLAY LAYOUT

PRODUCT: FASTLANE COMPACT	
TITLE: DISPLAY LAYOUT OPTIONS	
DRAWN: RST	DRAWING No: S665_09_A0
DATE: 1.1.03	This document is the copyright of Integrated Design Ltd

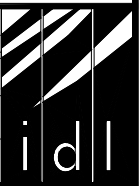

LID - SMOKED PERSPEX 923

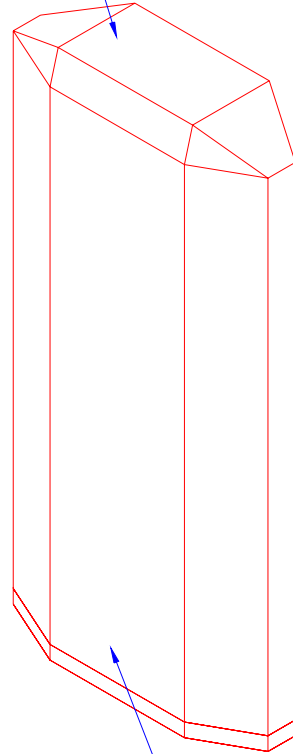

INNER SIDE PANEL -
BLACK PERSPEX 962

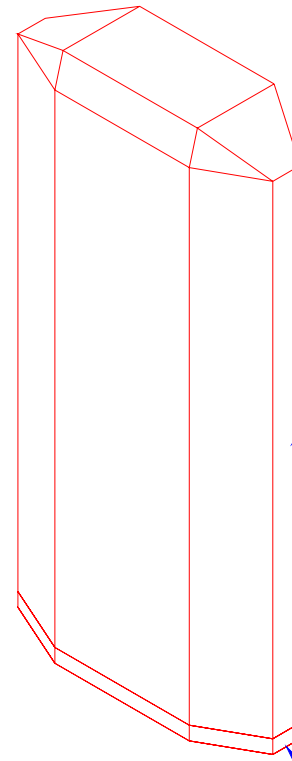

END -
ST/STEEL SATIN 304

BASE PLATE -
BLACK MILD STEEL

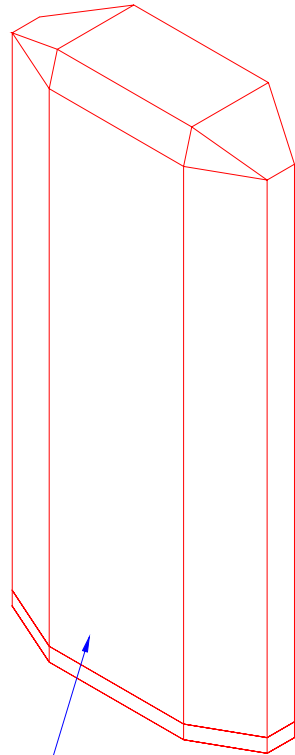

OUTER SIDE PANEL -
ST/STEEL SATIN 304

PRODUCT: FASTLANE COMPACT	
TITLE: MATERIAL SPECIFICATIONS	
DRAWN: RST	DRAWING No: S665_10_A0
DATE: 18.10.02	This document is the copyright of Integrated Design Ltd

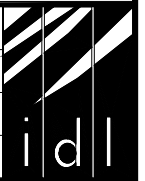

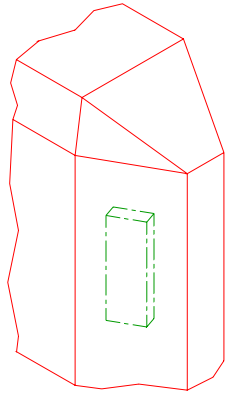

CARD READER POSITION - OPTION 1
SURFACE MOUNTED ON SIDE FACE

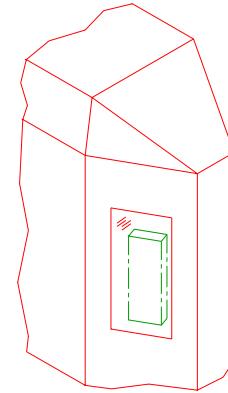

CARD READER POSITION - OPTION 2
BEHIND ACRYLIC WINDOW ON SIDE FACE

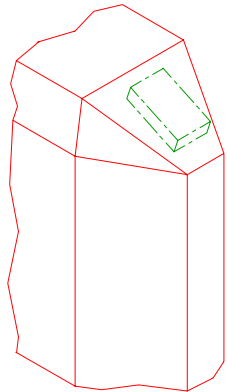

CARD READER POSITION - OPTION 3
SURFACE MOUNTED ON TOP FACE

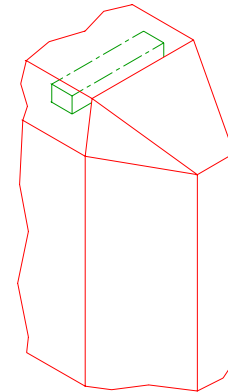

CARD READER POSITION - OPTION 4
UNDER ACRYLIC LID

PLEASE NOTE THAT WHEN USING SHORT RANGE
CARD READERS THE ACRYLIC LID MAY BE DAMAGED
BY PERSONS RUBBING THEIR CARD ON THE LID TO
GET THE CARD READ.
THIS DAMAGE WOULD NOT BE COVERED UNDER WARRANTY

PRODUCT: FASTLANE COMPACT

TITLE: CARD READER OPTIONS

DRAWN: RST

DRAWING No: S665_11_A1

DATE: 18.10.02

This document is the copyright of
Integrated Design Ltd



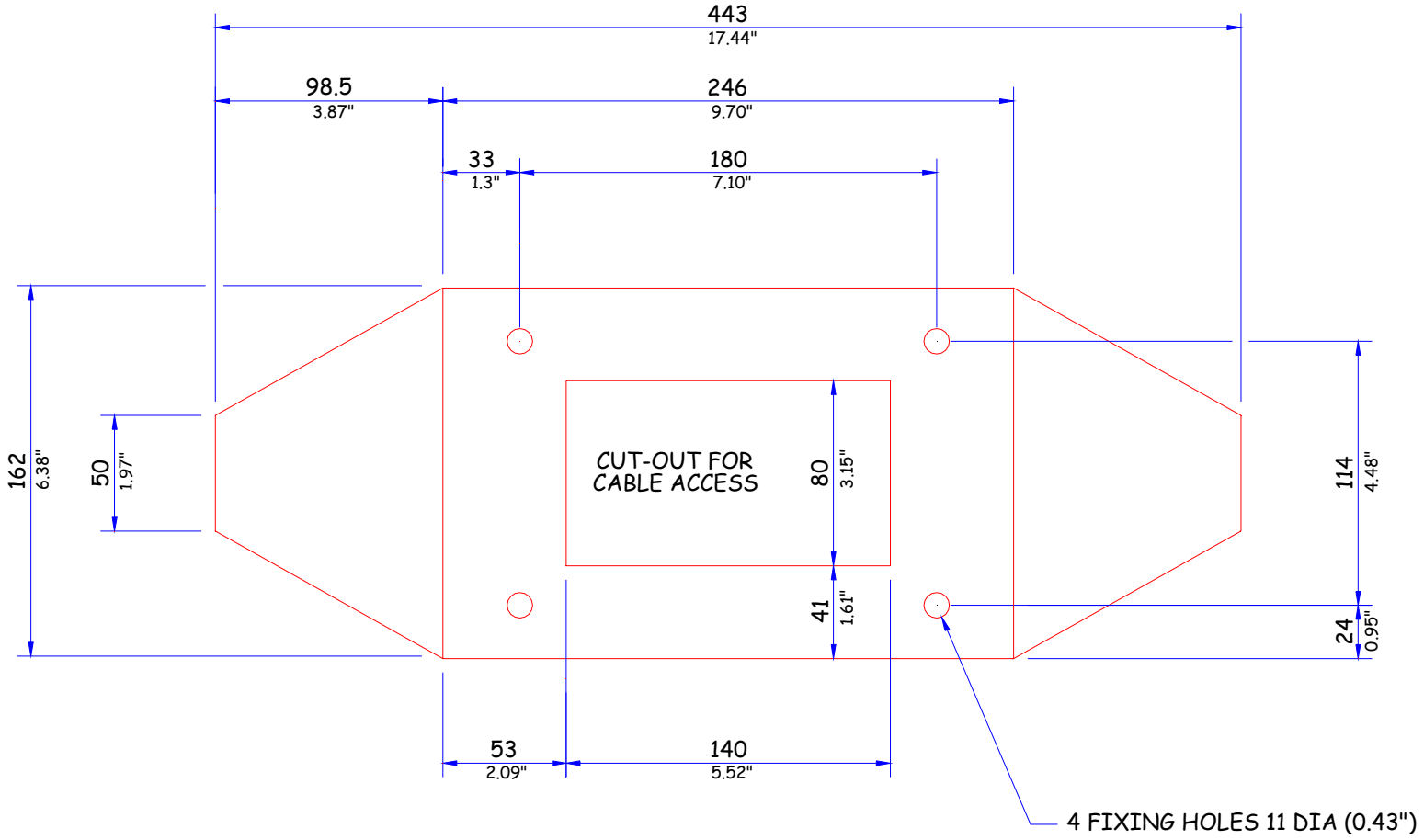

PRODUCT: FASTLANE COMPACT	
TITLE: BASE DRILLING TEMPLATE	
DRAWN: RST	DRAWING No: S665_12_A0
DATE: 18.10.02	This document is the copyright of Integrated Design Ltd

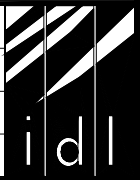

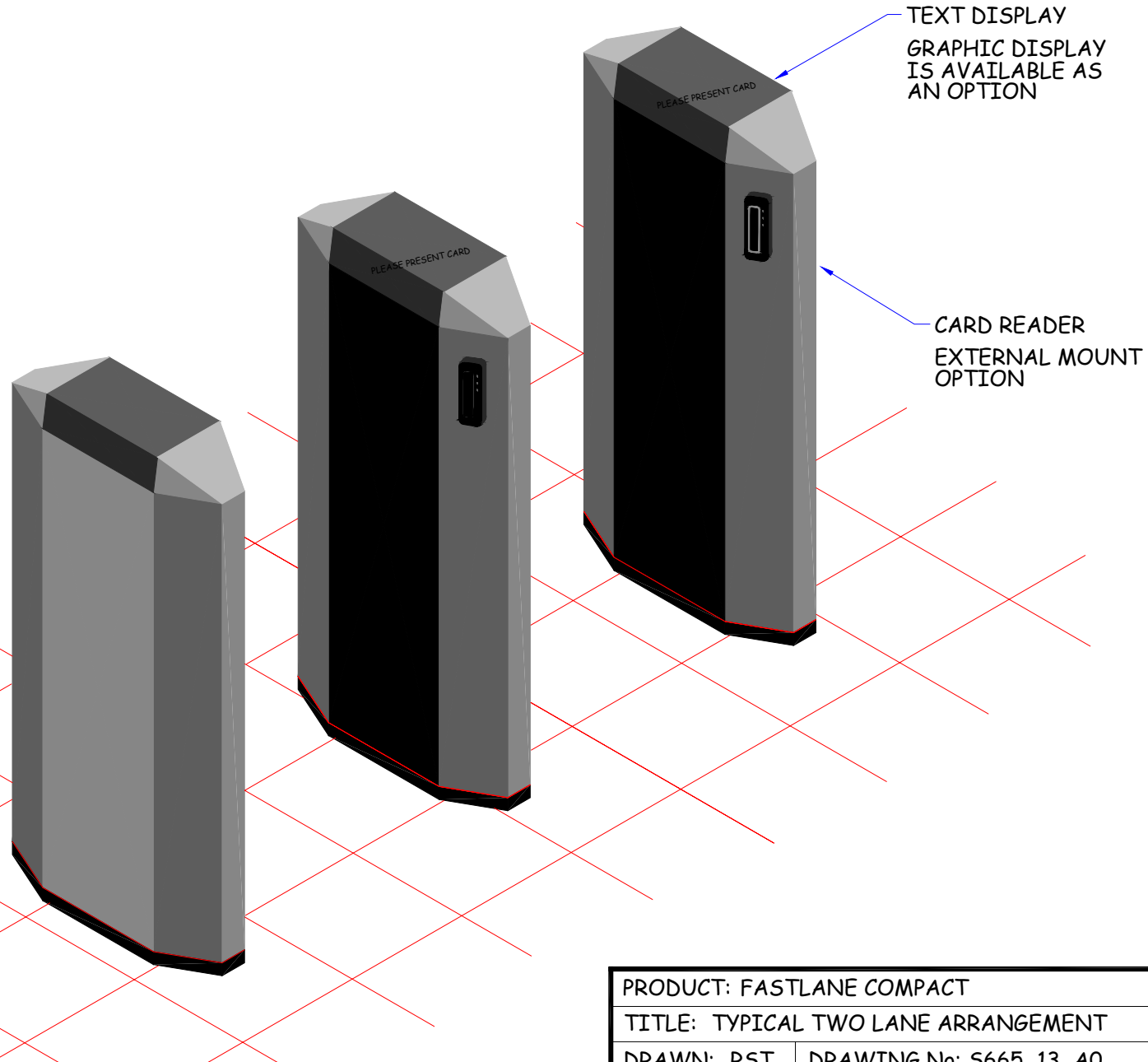

PRODUCT: FASTLANE COMPACT	
TITLE: TYPICAL TWO LANE ARRANGEMENT	
DRAWN: RST	DRAWING No: S665_13_A0
DATE: 18.10.02	This document is the copyright of Integrated Design Ltd

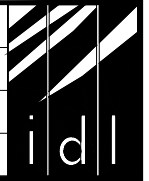

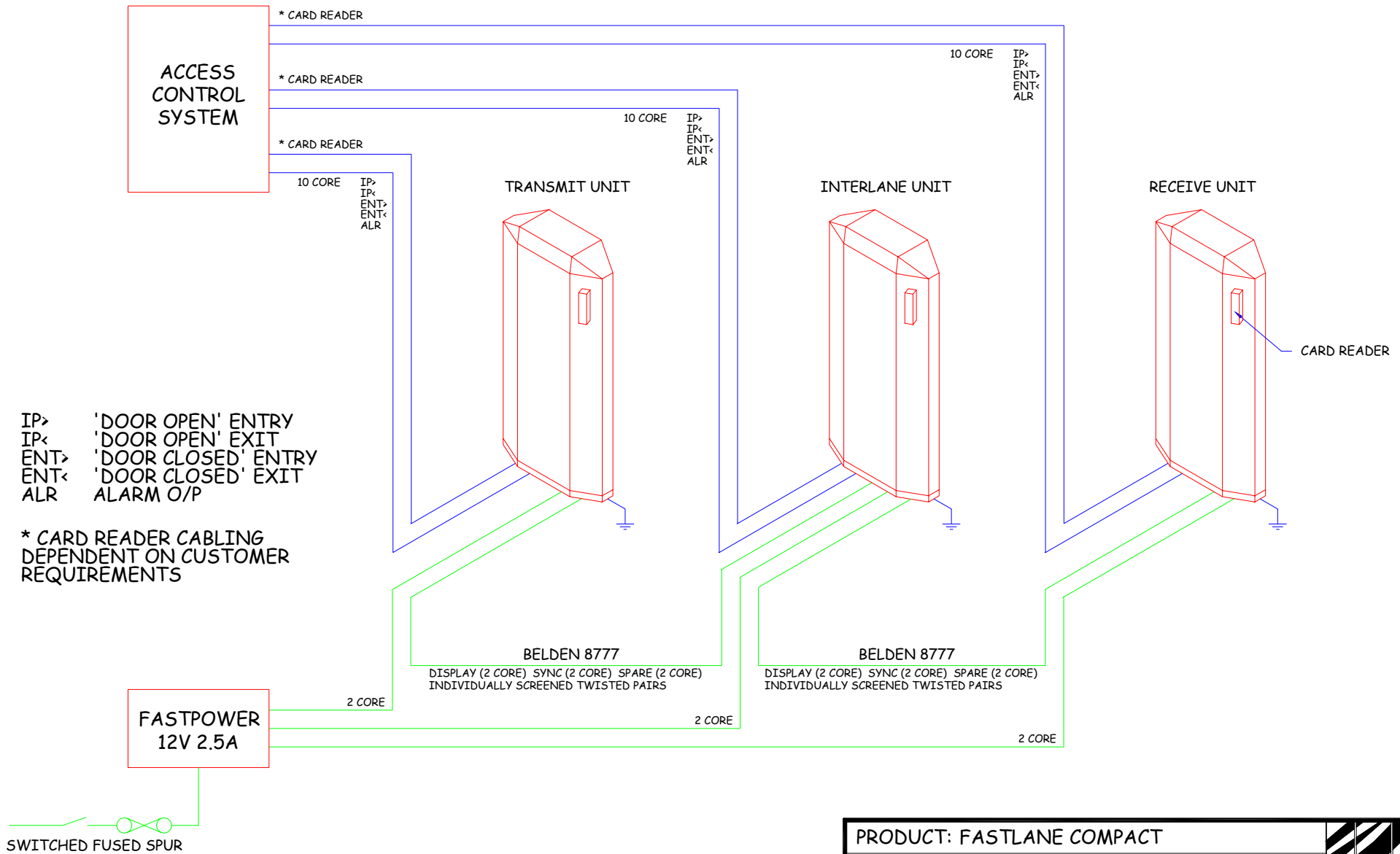

PRODUCT: FASTLANE COMPACT	
TITLE: CABLING REQUIREMENTS	
DRAWN: RST	DRAWING No: S665_14_A0
DATE: 18.10.02	This document is the copyright of Integrated Design Ltd

